

Ecofriendly Environment  
ISO 9001

# PRODUCT GUIDE

Self-priming slurry pump

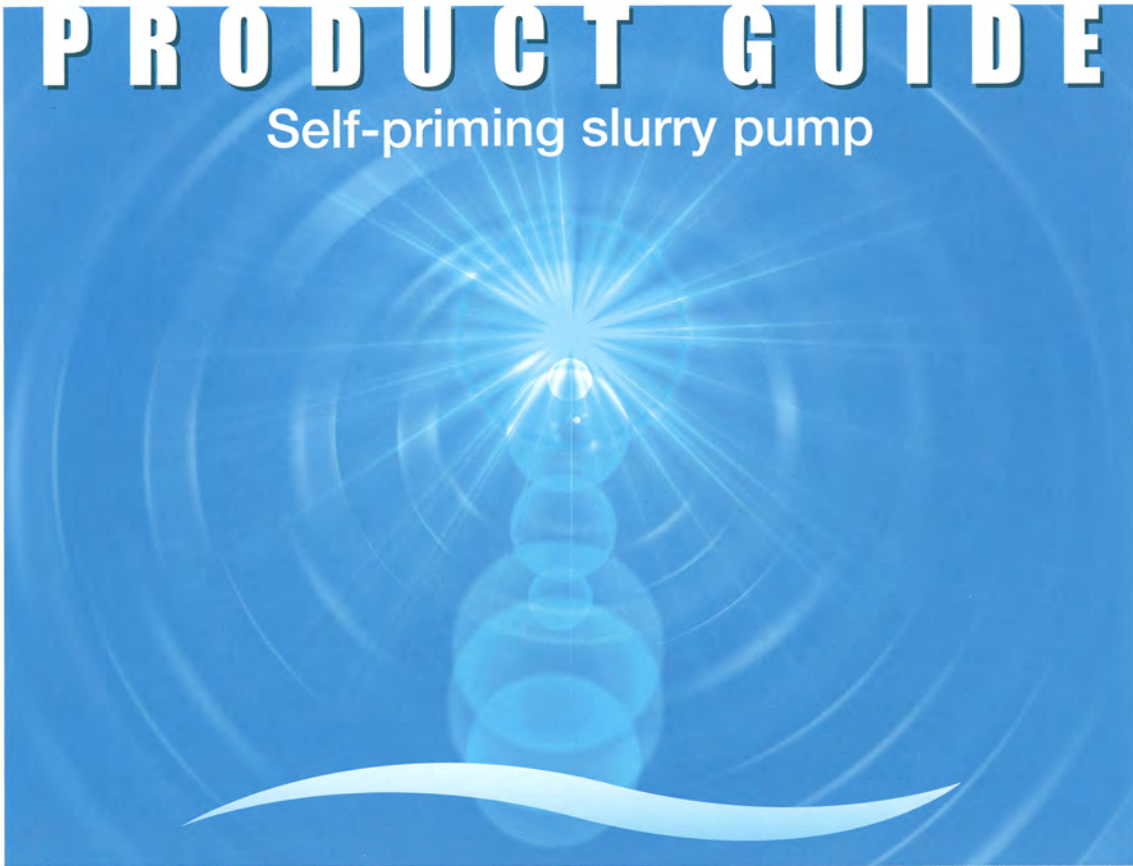

**Rubber Self-Priming Pump**  
**Seal Self-Priming Pump**  
**Through Self-Priming Pump**  
**Self-Priming Rubber Through Pump**

Since 1954

 MITSUWA PUMP CO.,LTD.

# Company Guide



## Profile

Name: MITSUWA PUMP CO.,LTD.  
President: Mikio Kobayashi  
Business: Manufacture of Environment pumps, Main product pump for industrial drainage operations: waste and garbage incinerating facilities.  
Address: 3617 Shinkurahara, Ooaza-Yamada, Touincho, Mie-Prefecture, Japan; 511-0251  
TEL 0594-76-1100  
FAX 0594-76-1101  
Establishment: Individual founding of company: July 1, 1954  
Founding of corporation: July 1, 1956  
Capitalization: 45,000,000yen  
Banks: Hyakugo Bank, Kuwana Branch  
The Bank of Tokyo Mitsubishi UFJ, Kuwana Branch  
Employees: 20 people



URL: <http://www.mitsuwapump.jp/>

## History

- 1954 The late Yoshio Kobayashi begins the manufacture of self-priming pumps for civil engineering works.
- 1956 A corporate organization, MITSUWA PUMP CO., LTD. is established.
- 1974 Obtains the permission to engage in the manufacture of machinery and instruments (Permission of the Government of Mie Prefecture No.49-351).
- 1975 Ships 400 pumps for agriculture to Laos as part of the United Nation's initiative to aid economically underdeveloped nations.
- 1979 Ships pumps to be mounted on cultivators under the initiative of UNICEF of the United Nations.
- 1980 Ships 1,000 pumps for agriculture as aid to the Cambodian refugees under the initiative of UNICEF of the United Nations.
- 1981 Ships 1,000 pumps for agriculture to Kenya under the initiative of UNICEF of the United Nations.
- 1985 Starts the manufacture and sales of "Seal self-priming pumps".
- 1991 Starts the manufacture and sales of "Self-priming Rubber pumps". (bore diameters:50A 2inch and 80A 3inch).
- 1994 Starts the manufacture and sales of "Self-priming Rubber pumps". (bore diameters:25A 1inch).
- 1998 The company headquarters moved to the newly constructed head office.
- 1998 Starts the manufacture and sales of "Through self-priming non-clog pumps". (2inch, 2.5inch, 3inch).
- 1999 Specifies the standard specifications for "Self-priming Through pumps" JARUS.
- 2001 It is certified as a new venture for development of new technologies by the organization for laying the foundations of the medium and small scale enterprises and starts the development of the large rubber self-priming pumps.
- 2001 Obtains the ISO 9001: 2000 certificate.
- 2004 Starts the manufacture and sales of "Big rubber self-priming pumps" (100A 4inch).
- 2005 Starts the manufacture and sales of "Self-priming Rubber Through pump" (80A 3inch).
- 2006 Celebrates the 50th anniversary.
- 2008 Starts the manufacture and sales of "Self-priming Rubber Through pump" (50A 2inch).

## Manufacturer's Line



Materials storage site



Machining



Assembling



Setting



Testing

## Main Users

- **Ceramic, glass and building materials production plants**  
INAX TOTO Asahi Kasei Corporation Itochu Ceratech Corporation DAITO Toki-shi Ceramic Material Industrial-Committee Nichiha Corporation NGK Insulators, Ltd. Nippon Electric Glass Co., Ltd.
- **Various types of plants and equipment manufacturers**  
INAX AQUAS Ataka Daiki engineering Co., Ltd. Ebara Corporation Organo Corporation Kyowa Kako Co., Ltd. Kubota Corporation Kurita Water Industries Ltd. Kotobuki Industries Co., Ltd. Sumitomo Heavy Industries, Ltd. Taikisha Ltd. Drico Ltd. Nishihara Environment Technology, Inc. Nishimura Tekkousho Hitachi Plant Techno Co., Ltd. Fujikasui Engineering Co., Ltd. Fujiyoshi Kogyo K.K. Makino Corporation
- **Semiconductors and liquid crystal products manufacturing plants**  
FDK NEC SUMCO TDK IBIDEN Co., Ltd. SHARP Toppan Printing Co., Ltd. Hitachi Ltd. Fuji Photo Film FUJITSU Matsushita Electric Industrial Co., Ltd. Murata Manufacturing Co., Ltd. Metek Kitamura Co., Ltd.
- **Iron works, non-metallic materials manufacturing plants and plating plants**  
JFE Steel Corporation ST Products Inc. Kobe Steel, Ltd. Nippon Steel Corporation Sumitomo Metal Industries, Ltd. Sumitomo Light Metal Industries, Ltd. Nippon Mining & Metals Co., Ltd. Nisshin Steel Co., Ltd. Nippon Light Metal Co., Ltd. Fuji Titanium Industry Co., Ltd. YODOKO
- **Automobiles and ships manufacturing plants**  
IHI Corporation Aisin Seiki Co., Ltd. Suzuki Motor Corporation Sumitomo Rubber Industries, Ltd. Daihatsu Motor Co., Ltd. DENSO Corporation TOYOTA Motor Corporation Toyota Industries Corporation MAZDA Motor Corporation Mitsubishi Motor Corporation
- **Paper manufacturing plants**  
Ehime Paper Mfg. Co., Ltd. Oji Paper Co., Ltd. Osaka Paper Co., Ltd. Daio Paper Corporation Chuetsu Pulp & Paper Co., Ltd. Tokyo Paper Mfg. Co., Ltd. Nagoya Pulp Nippon Paper Industries Co., Ltd. Fuji Paper
- **Chemicals and inorganic chemicals manufacturing plants**  
Ishihara Sangyo Kaisha, Ltd. Konan Chemical Mfg. Co., Ltd. CATALYSTA & CHEMICALS IND.CO.,LTD Sobueclay Co., Ltd. Teyca Co., Ltd. TOAGOSEI Co., Ltd. Toshin Chemical Industry Co., Ltd. Maruo Calcium Co., Ltd. Mitani Kogyo Co., Ltd. Mitsui Chemicals, Inc. Yabashi Industries Co., Ltd.
- **Others**  
Asahi Brewries, Ltd. Sapporo Brewries, Ltd. Sanix Incorporated Sanvic Co., Ltd. Shikoku Electric Power Co., Ltd. Japan Recycle Daisei Co., Ltd. J-Power Higashimaru Shoyu Co., Ltd. Mizushima Eco-works Co., Ltd.

# Self-Priming Rubber Pump

## SM-RZ Series

Bore size : 20mm/50mm/80mm

### Low wear-High corrosion Resistance materials for Long Life.

Patent

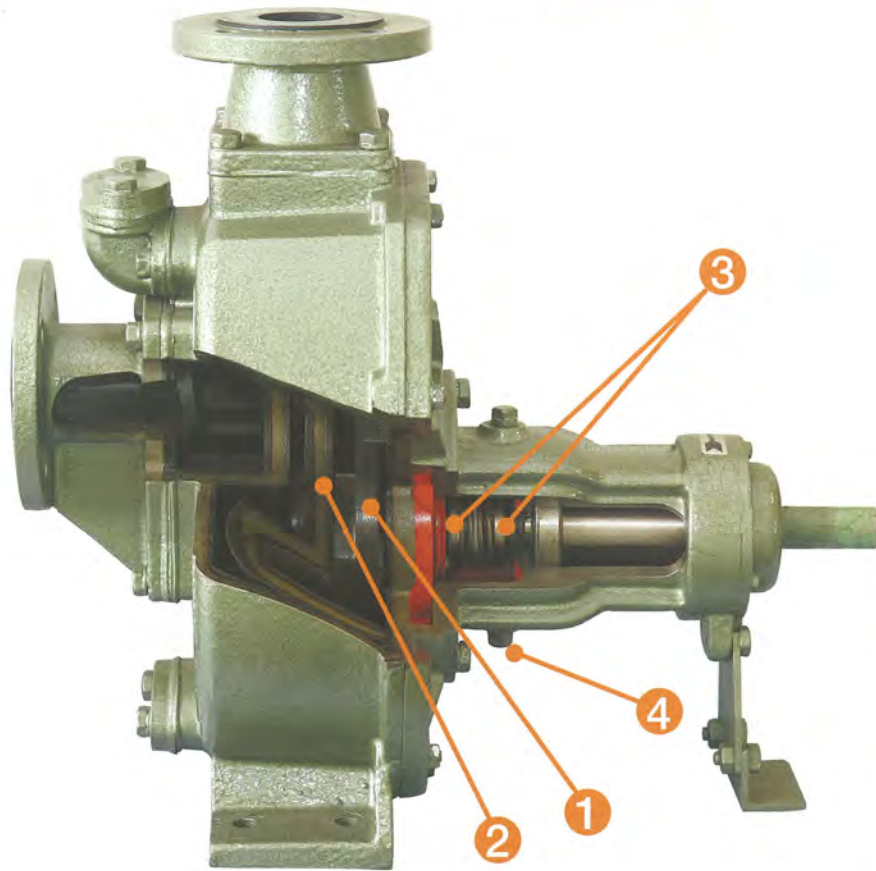

#### Applications

- Ceramic and glass raw production processes.
- Wastewater treatment for L.C.D. and semiconductor plants.
- Garbage and industrial waste treatment plants.
- Inorganic chemical liquid transfer.
- Removal and transfer sludge and mud.
- Environment and water treatment plant.

|  |   |   |
|--|---|---|
| <p><b>1</b><br/>Rubber-lining impeller</p>           |  | <p>The impeller is an open type with a self-priming function. The impeller is separated from the mechanical seal so that it will not be damage.</p>   |
| <p><b>2</b><br/>Rubber-lining Inner casing</p>       |  | <p>The volute chamber for self-priming has been inserted ideally to permit easy disassembly and reassembly.</p>   |
| <p><b>3</b><br/>Double mechanical seal (SiC×SiC)</p> |  | <p>The double sealing of the casing (primary side) and bearing (secondary side) ensures perfect sealing. The rubber section comes in NBR, Viton, and EPDM to permit appropriate selection according to usage.</p> |
| <p><b>4</b><br/>Sight glass</p>                      |  | <p>A sight glass is provided visually to monitor the mechanical seal oil for contamination of the oil.</p>  |

The wetted surface of the self-priming slurry pump is lined with molded rubber. The SM-RZ Series, epochal pumps with improved sealing performance, abrasion resistance, and corrosion resistance ensure long life, space saving, and reduction in cost

#### Features

- Self-priming pump (Have Pump Vacuum)
- Rubber Lined, for Good corrosion and Wear resistance.
- Double Mechan seal (SiC × SiC) to eliminate spillage, improved sealings. Longer seal Life.
- Robust construction for Difficult Applications.
- Easy maintenance with Back pull out to prevent dismountance Suction or Delivery pipes.
- The oil-filled closed Mechanical box prevents due to operation with out liquid.

#### Sectional View

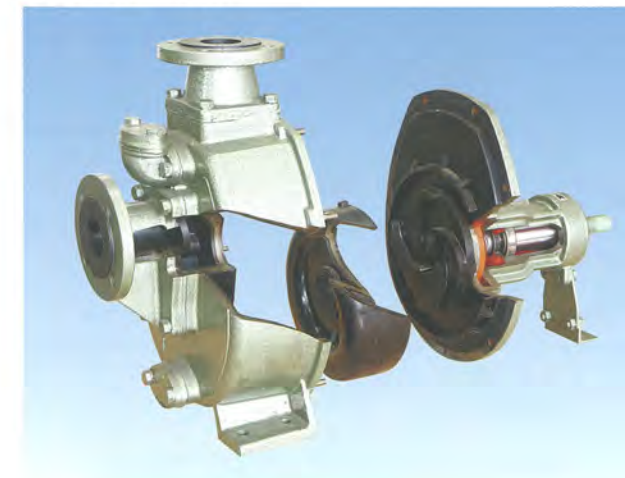

#### Selection chart Model 1SM-RZ 2SM-RZ1 3SM-RZ

##### 1SM-RZ 25mm

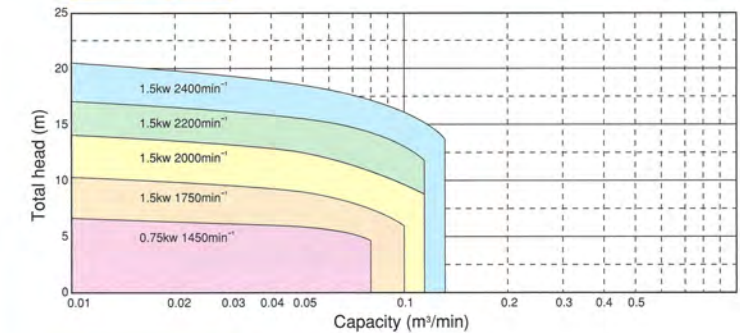

##### 2SM-RZ1 50mm

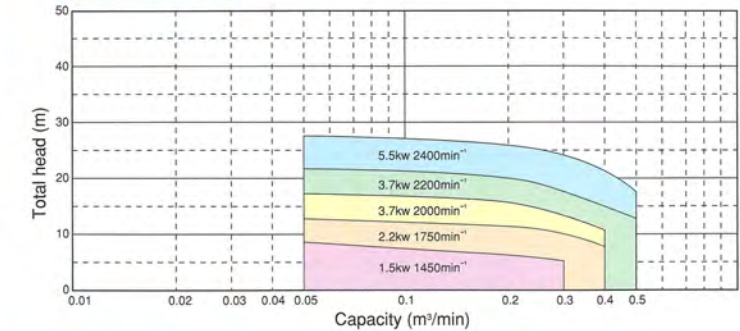

##### 3SM-RZ 80mm

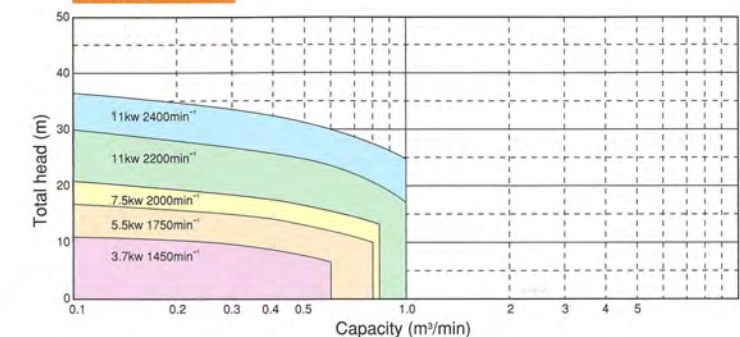

# Seal Self-Priming Pump

## SM Series

MITSUWA's standard model made of Cast iron, main parts of HiCr and Stainless for Specific use according to application.

Bore size : 40mm/50mm/65mm/80mm  
100mm/150mm

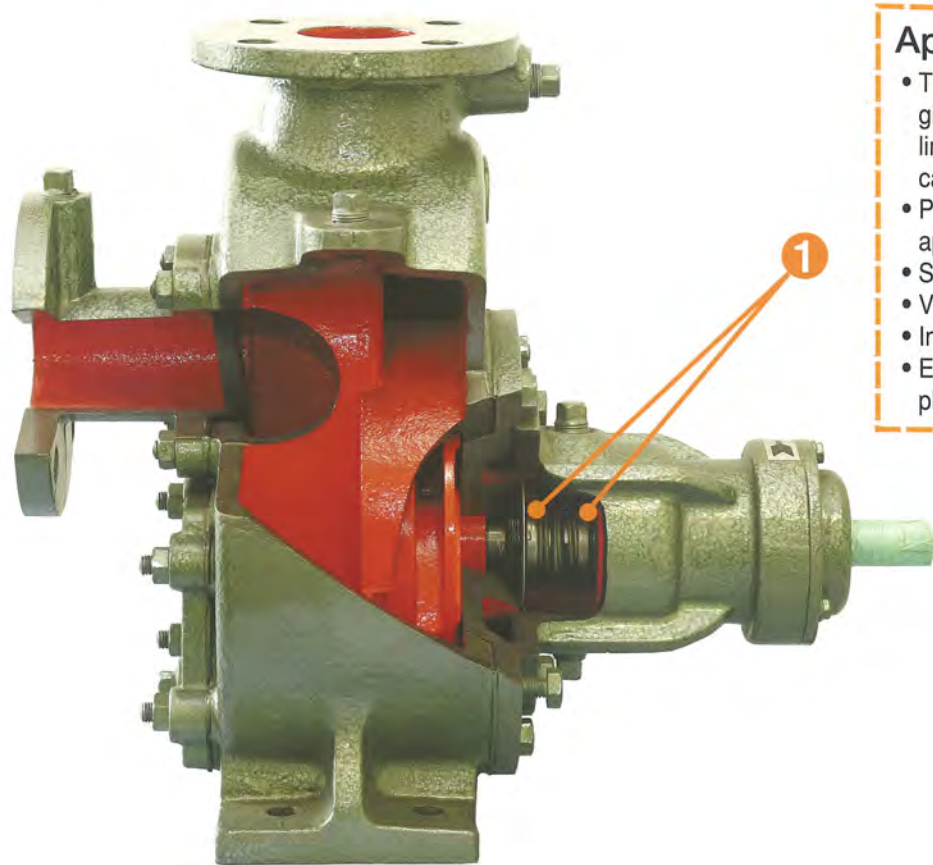

### Applications

- Transfer of various ceramic and glass raw materials, ferrite solutions, lime liquid, activated carbon, and caustic liquid
- Paper and rubber mills (for application of releasing agent)
- Stack gas desulfurization facilities
- Vacuum header system
- Industrial wastewater treatment plant
- Environmental and water treatment plant

### Features

- \* A double mechanical seal (SiC x SiC) is used in the gland to improve the sealing performance and eliminate leakage.
- \* Easy maintenance without removing the piping
- \* A variety of models permit selection of the standard cast iron type (SM), main parts of chromium type (SMC) with excellent abrasion resistance, and stainless-steel type (SMS) with excellent acid resistance according to the usage and application.
- \* Simple replacement of the impeller and antifriction plate ensures almost complete recovery of the original self-priming force.
- \* The impeller has a special structure to reduce clogging without losing the strong vacuum force.

### Selection chart Model 1.5SM 2SM 2.5SM 3SM 4SM 6SMZ2

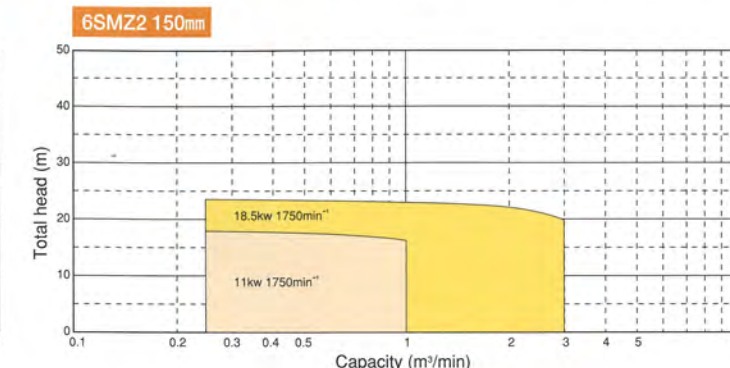
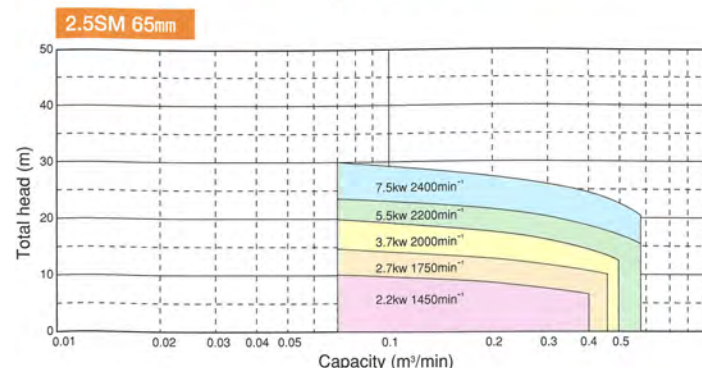
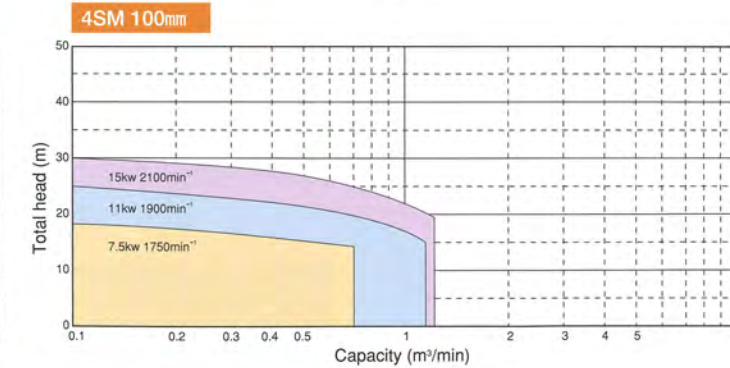
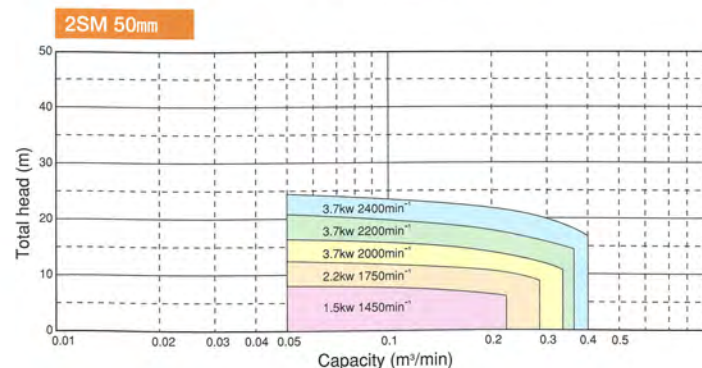
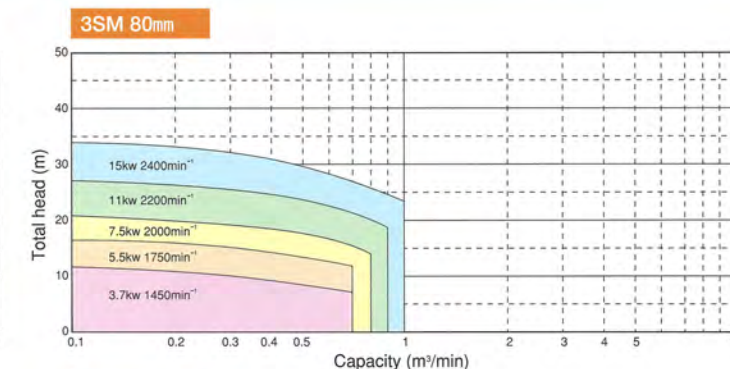
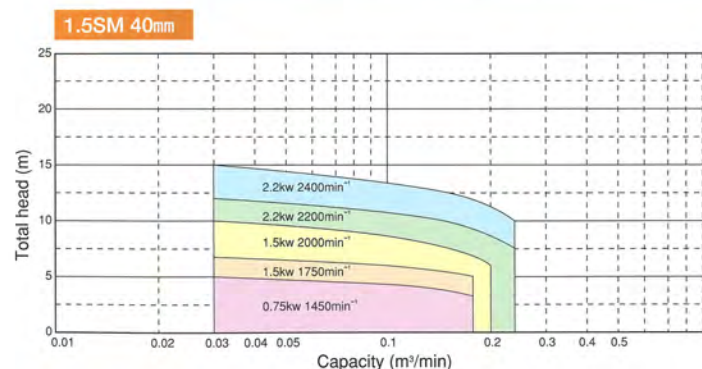

1

Double mechanical seal (SiC x SiC)



The double sealing of the casing (primary side) and bearing (secondary side) ensures perfect sealing. The rubber section comes in NBR, Viton, and EPDM to permit appropriate selection according to usage.

### Direct Coupling type



### V-Belt type



# Self-Priming Through Pump

## SMJ/SMO Series

No-clogging, high vacuum, and Leak-proof operation.

Patent

Stationery type



Portable type



JARUS sludge-removing, self-priming pump without clogging for environment-related usage



Clogging inside pump



Clogged impeller



The clogging-free impeller solves the problem of clogging at once. (Patented)

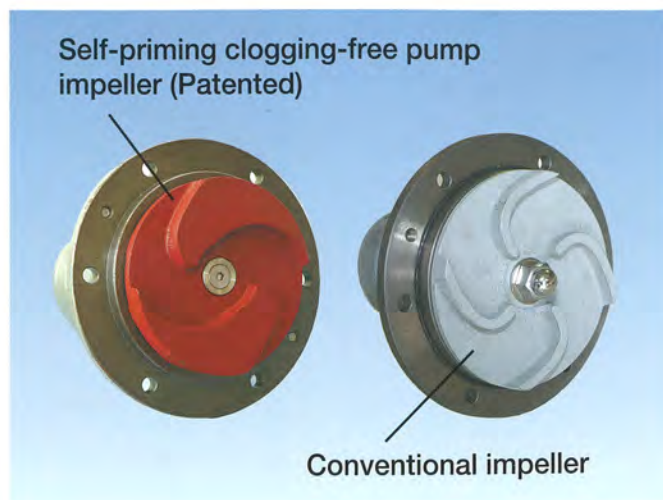

Self-priming clogging-free pump impeller (Patented)

Conventional impeller

The special impeller structure eliminates the problem of clogging. Generating exceptionally strong vacuum force, the pump is equipped with a double mechanical seal in the gland to eliminate leakage and substantially reduce the maintenance work. The SMJ/SMO Series, long-life self-priming pumps for sludge removal without leakage or staining, are suitable for the drainage work.

[JARUS Standard Specification Product]

### Features

- \* The special impeller structure eliminates the problem of clogging, allowing solids of about 20mm for 2inch-30mm for 3inch in size to pass through.
- \* The double mechanical seal used in the gland to improve the sealing performance and eliminate leakage contributes to the beautification of the environment.
- \* The high-vacuum completely self-priming centrifugai pump ensures excellent sludge removing.
- \* Simple replacement of the impeller and antifriction plate ensures almost complete recovery of the original self-priming force.
- \* The pump ensures easy maintenance without removing the piping and increases the pump discharge substantially at the specified point to shorten the operation time.
- \* Low noise in comparison with competitorfs products.

### Applications

- For environmental and water treatment plant and removal of sludre in general

### Selection chart Model 2SMJ 2SMO 2.5SMO 3SMO

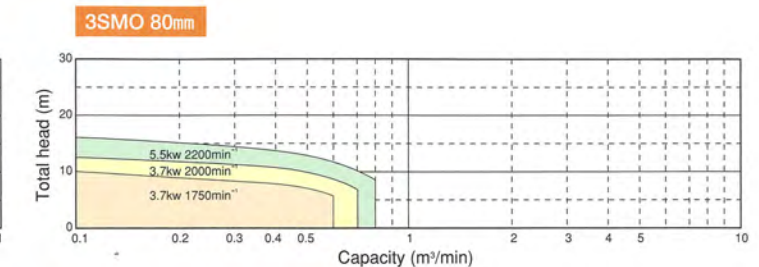
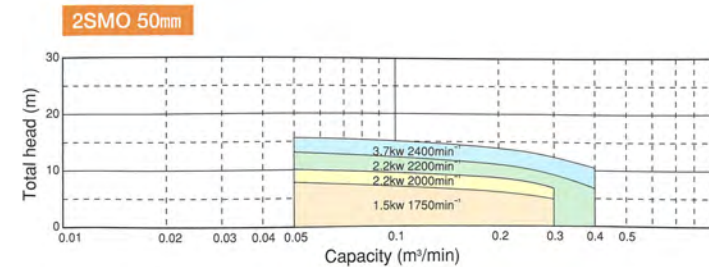
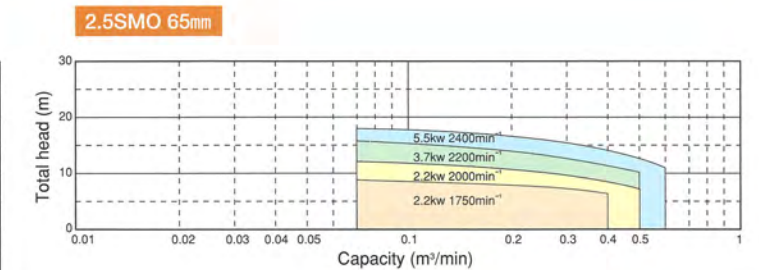
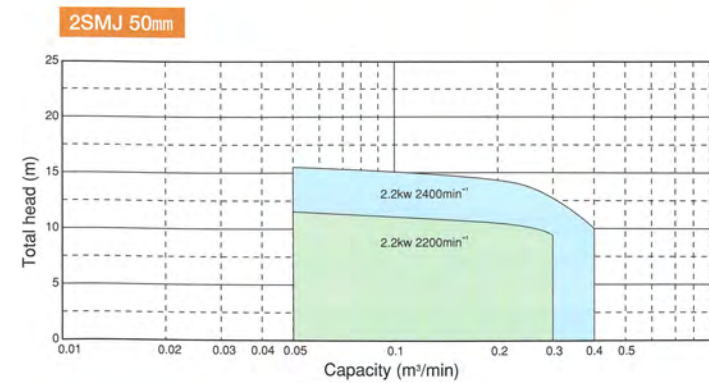

# Self-Priming Rubber Through Pump

## RO(S) Series

Superior resistance to wear and corrosion, non-clogging, and self-priming

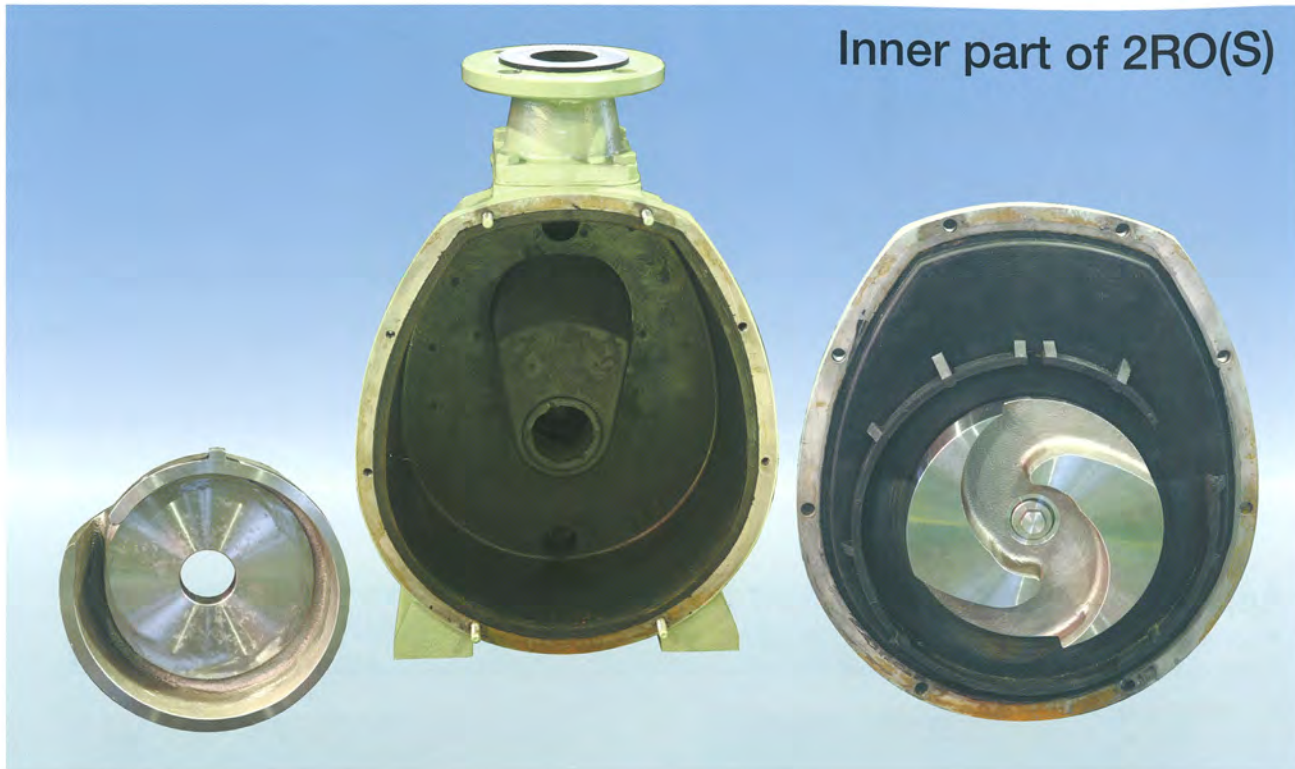

### Mission Statement

- Do much for the environment, resources (recycling) and energy (energy saving and alternative energy).
- Keep you connected to the people; create human-friendly work environment.

Non-clogging, self-priming sludge pump with rubber lining

Self-Priming Rubber Through Pump



**New!**

The RO(S) Series materialized through an array of tests with waste liquid and sludge from gasification melting furnaces, two types of diameter are available: 50mm and 80mm

### Problems of Conventional (SCS/Resin Pumps)

1. Chlorination is required; corrosion resistance is necessary.
2. Ash sluicing increases chloride concentration.
3. The pump gets clogged with sludge/slurry.
4. Leakage from the pump gland is troublesome.
5. High price and high maintenance cost.

### Self-Priming Rubber Through Pump (Rubber)

1. The pump surface is corrosion-resistant enough to even chlorine.
2. The rubber lining provides excellent resistance to corrosion by chloride attack.
3. A non-clogging type impeller adopted for the new RO(S) Series ensures clogging-free operation up to the maximum grain size of 25φ.
4. The double mechanical seal used in the gland maximizes the sealing performance and minimizes leakage.
5. Low price and reduced maintenance cost (almost 50% cutdown compared with conventional types)

### Selection chart Model 2RO(S) 3RO(S)

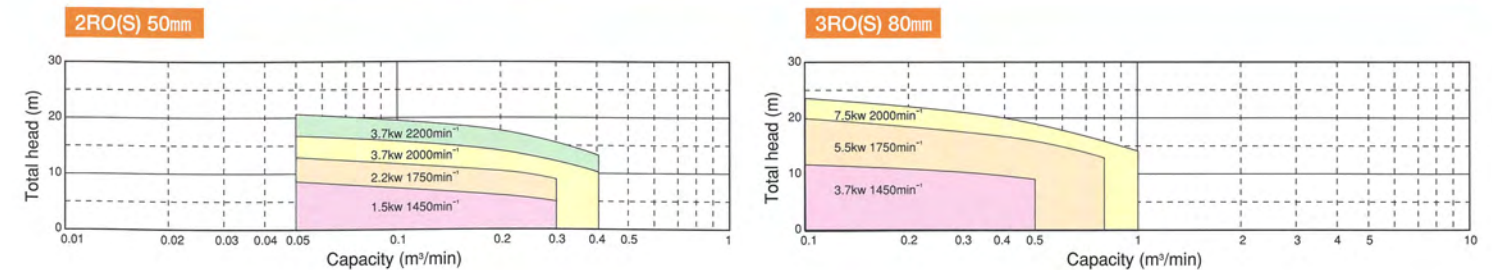



 **MITSUWA PUMP CO.,LTD.**

3617 Shinkurahara, Ooaza-Yamada, Touincho, Mie-Prefecture, Japan; 511-0251  
TEL 0594-76-1100 FAX 0594-76-1101

URL <http://www.mitsuwapump.jp/> E-mail: [m-k@mitsuwapump.jp](mailto:m-k@mitsuwapump.jp)